

# **DAYTONA**

## **ANIMA 160FDX ENGINE**

### Owner's Manual

ENGINE No. ANIMA160FDX: 0000000001-



***DAYTONA*** corp.



## INTRODUCTION

---

Thank you for purchasing of a “ANIMA Engine”.

This manual explains operation, inspection, basic maintenance of the engine.

If you have any questions, please contact the dealer you purchased the engine/bike from.

Please read this manual very carefully before use.



### WARNING

1. ANIMA ENGINE is designed strictly FOR COMPETITION USE, ONLY ON A CLOSED COURSE. It is illegal to use this engine on any public road or highway. Off-road use on public space is also illegal.  
Please check local regulation before use.
2. This engine is to be used by EXPERIENCED RIDERS ONLY.  
Fatal accident may be caused unless it is used by experienced riders or maintained by professional and experienced mechanics.
3. This engine is to be maintained by professional and experienced mechanics.  
Serious damage may occur, otherwise.
4. This manual explains ONLY THE BASIC operation, inspection and maintenance, but it is customer's responsibility to maintain the engine to the best possible performance, depending on the circumstances of the time.

## **CUSTOMER'S RESPONSIBILITY & CUSTOMER SERVICE**

---

### **GENERAL EXCLUSIONS**

Any failures caused by the following reasons are NOT considered as the defects of Products.

- (1) Overheating due to improper engine oil temp. control



### **WARNING**

**ENGINE OIL TEMPERATURE MUST BE CONTROLLED AT 90 DEGREES CELSIUS (194 DEGREES FAHRENHEIT) OR LOWER.**

**Serious damage will occur in the engine if engine oil temperature exceeds 90 degrees Celsius or 194 degrees Fahrenheit.**

**It is solely customer's responsibility to control the engine oil temperature.**

- (2) Installation of parts or accessories that is not originally equipped on Products.
- (3) Abnormal strain, neglect, or abuse
- (4) Accident or collision damage
- (5) Modification to original parts
- (6) Lack of proper maintenance
- (7) Damage due to improper transportation or use

### **THE CUSTOMER'S RESPONSIBILITY**

THE CUSTOMER'S RESPONSIBILITY shall be :

- (1) Operate and maintain Products as specified in the appropriate Owner's Manual
- (2) Prohibit the modification of the product

### **CUSTOMER SERVICE**

If Products require services, you must take it to the authorized dealer, who is appointed by authorized local distributors of DAYTONA.

DAYTONA Corp. JAPAN is NOT in the position to take care of services of any kind with the customers or authorized dealers due to the contract with authorized local distributors.

## **CONTENTS**

---

INTRODUCTION	Page 1
CUSTOMER'S RESPONSIBILITY & CUSTOMER SERVICE	Page 2
CONTENTS	Page 3
PART NAMES	Page 4
GENERAL SPECIFICATIONS	Page 5
MAINTENANCE SPECIFICATIONS	Page 6 – 9
MAINTENANCE INTERVALS	Page 10 - 12
PRE-OPERATION INSPECTION AND MAINTENANCE	Page 13 - 19
ENGINE OIL LEVEL INSPECTION	Page 13
CARBURETOR SETTING	Page 14 – 16
IGNITION TIMING SELECTION	Page 17
REV LIMITER SELECTION	Page 18
ENGINE OIL TEMPERATURE CONTROL	Page 19
ELECTRICAL DIAGRAM	Page 20
TIGHTENING TORQUE	Page 21

## PART NAMES

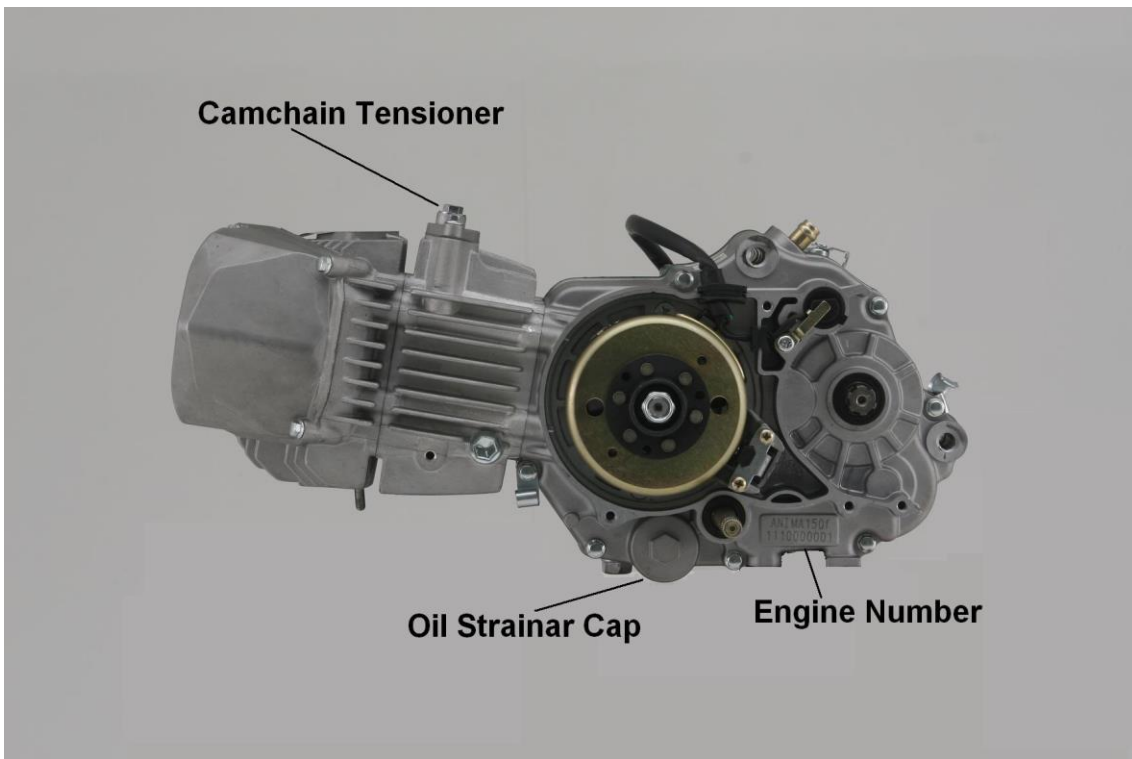
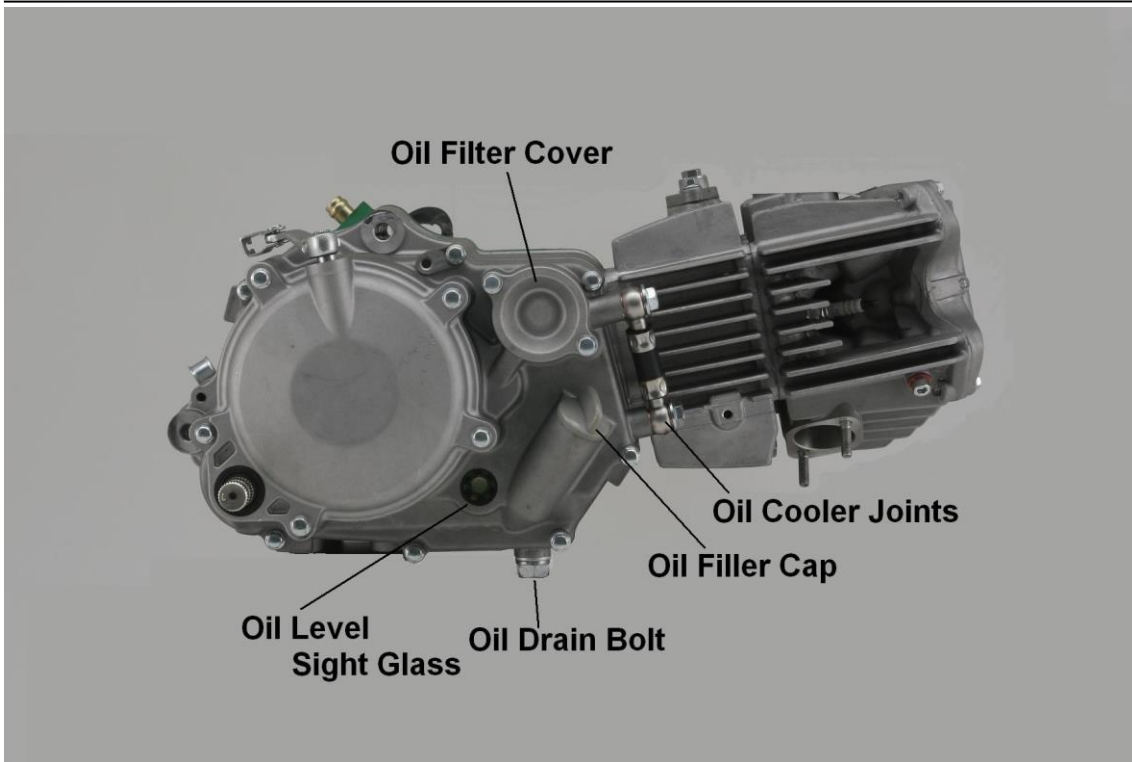

## GENERAL SPECIFICATIONS

ENGINE	
Engine Weight (Dry)	21.5 kg
Engine type	Air Cooled 4-stroke SOHC
Cylinder arrangement	Single cylinder, Horizontally mounted
Displacement	159.71 cm <sup>3</sup>
Bore x stroke	62. 0x 52.9mm
Compression ratio	12.1 : 1
Starting system	Kick (Kick pedal is NOT included in the Engine Kit) With Decompression System
Lubrication system	Wet sump
Recommended Engine Oil	SAE 10W - 40 or higher grade API "SG" or higher grade
Engine oil capacity	
Periodic oil change	0.60 L
With oil filter replacement	0.65 L
Total amount	0.70 L
	* Need more amount of oil when oil cooler is in use
Spark plug	
Type/manufacturer	ER9EH / NGK (resistance type)
Gap	0.6 ~ 0.7 mm (0.024 ~ 0.028 in)
Clutch type	Wet, Multi-plate 6-disc
Transmission	
Primary reduction system	Gear
Primary reduction ratio	67/18 (3.722)
Transmission type	4-Speed
Gear ratio	(Counter / Main)
1st	34/13 (2.6153)
2nd	26/15 (1.7333)
3rd	26/20 (1.3000)
4th	24/23 (1.0435)
GEAR SHIFT PATTERN	N-1-2-3-4
Electrical	
Ignition system	AC-CDI
Generator system	AC magneto

## MAINTENANCE SPECIFICATIONS

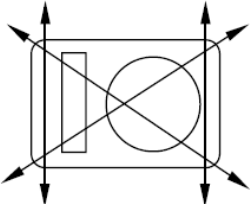
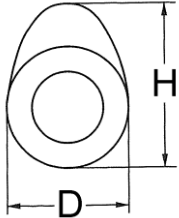
Item	Standard	Limit
Cylinder head Warp limit 	----	0.05 mm (0.002 in)
Cylinder: Bore size Out of round limit	62.00 - 62.015mm (2.4409 – 2.4415) ----	---- 0.05 mm (0.002 in)
Camshaft: Drive method Cam dimensions 	Chain drive (Left)	----
Intake	“H” 30.18 ~ 30.30 mm (1.1882 ~ 1.1929 in) “D” ---- ----	29.84 mm (1.1748 in) ---- ----
Exhaust	“H” 30.21 ~ 30.33 mm (1.1894 ~ 1.1941 in) “D” ---- ----	29.87 mm (1.1760 in) ---- ----

## MAINTENANCE SPECIFICATIONS

Item	Standard	Limit
Timing chain: Timing chain No. of links Timing chain adjustment method	94 link  Automatic	----  ----
Valve, valve seat, valve guide: Valve clearance (cold) IN  EX	0.05 ~ 0.07 mm (0.0020~ 0.0028 in) 0.05 ~ 0.07 mm (0.0020~ 0.0028 in)	----  ----
Valve dimensions:		
“A” head diameter IN EX “B” face width IN EX “C” seat width IN EX “D” margin thickness IN EX Stem outside diameter IN EX Guide inside diameter IN EX Stem-to-guide clearance IN EX	24.4 ~ 24.6 mm (0.9606 ~ 0.9685 in) 20.9 ~ 21.1 mm (0.8228 ~ 0.8307 in) --- --- 0.8 ~ 1.0 mm (0.0314 ~ 0.03937 in) 0.8 ~ 1.0 mm (0.0314 ~ 0.03937 in) ---- ---- 4.470 ~ 4.485 mm(0.17598 ~ 0.1766 in) 4.470 ~ 4.485 mm(0.17598 ~ 0.1766 in) 4.500 ~ 4.512 mm(0.17716 ~ 0.1776 in) 4.500 ~ 4.512 mm(0.17716 ~ 0.1776 in) 0.015 ~ 0.042 mm(0.0005 ~ 0.0016 in) 0.03 ~ 0.057 mm(0.0011 ~ 0.0022 in)	---- ---- ---- ---- 1.6 mm (0.0630 in) 1.6 mm (0.0630 in) ---- ---- 4.42 mm (0.1740 in) 4.42 mm (0.1740 in) 4.55 mm(0.1791 in) 4.55 mm(0.1791 in) 0.08 mm(0.003 in) 0.10 mm(0.004 in)
Valve spring: Free length IN ( φ 16.2) EX ( φ 16.2)	42.59 mm(1.6767 in) 42.59 mm(1.6767 in)	40.38 mm(1.5897 in) 40.38 mm(1.5897 in)

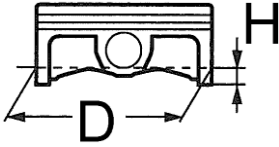
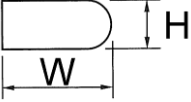
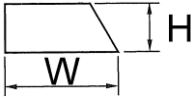
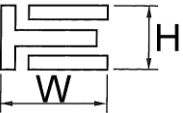

## MAINTENANCE SPECIFICATIONS

Item	Standard	Limit
Piston: Piston to cylinder clearance  <div style="text-align: center;">             Piston size "D"   </div> <div style="text-align: center;">             Measuring point "H"              Piston off-set              Piston pin bore inside diameter              Piston pin outside diameter           </div>	0.01 ~ 0.04 mm (0.00039 ~ 0.00157in)  61.975 ~ 61.99 mm (2.4399 ~ 2.4405 in)   8 mm (0.31 in) ---- 14.002 ~ 14.013 mm (0.5513 ~ 0.5517 in) 13.995 ~ 13.998 mm (0.5510 ~ 0.5511 in)	0.1mm(0.004 in)  ----  14.06 mm (0.5535 in) 13.97 mm (0.55 in)
Piston rings:  <div style="text-align: center;">  </div> Top ring: Dimensions (H x W) End gap (installed) Side clearance (installed)  <div style="text-align: center;">  </div> 2nd ring: Dimensions (H x W) End gap (installed) Side clearance  <div style="text-align: center;">  </div> Oil ring: Dimensions (H x W) End gap (installed)	 0.8 x 2.25 mm (0.06 x 0.09 in) 0.05 ~ 0.20 mm (0.006 ~ 0.010 in) 0.015 ~ 0.045 mm(0.0012 ~ 0.0026in)  0.8 x 2.25 mm (0.06 x 0.09 in) 0.05 ~ 0.20 mm (0.006 ~ 0.010 in) 0.015 ~ 0.045 mm(0.0012 ~ 0.0026in)	 0.4 mm (0.020 in) 0.10 mm (0.005 in)  0.4 mm (0.031 in) 0.10 mm (0.005 in)  ---- 0.9 mm (0.005 in)

## MAINTENANCE SPECIFICATIONS

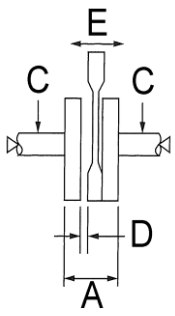
Item	Standard	Limit
Crankshaft: Crank width "A" Runout limit "C" Big end side clearance "D" Small end free play "E" 	42.2 mm (1.66142 in) 0.03 (one-side) 0.1 ~ 0.35 mm (0.0039 ~ 0.0137 in) ----	---- 0.1 mm (0.0039 in) 0.6 mm (0.0236 in)
Clutch: Friction plate thickness Quantity Clutch plate thickness Quantity Warp limit Clutch spring free length Quantity	2.9 ~ 3.1 mm (0.114 ~ 0.122 in) 6 0.9 ~ 1.0 mm (0.035 ~ 0.039 in) 5 ---- ---- 4	2.7 mm (0.106 in) ---- 0.7 mm (0.0275 in) ---- 0.2 mm (0.0787 in) ---- ----

## MAINTENANCE INTERVALS

Item	After break-in (50km)	Every race	Every third (or 500 km)	Every fifth (or 1,000 km)	As required	Remarks
ENGINE OIL Replace Inspect	●	●			●	
ENGINE VALVES Check the valve clearances Inspect Replace	●		● ●		●	The engine must be cold. Check the valve seats and valve stems for wear.
VALVE SPRINGS Inspect Replace			●		●	Check the free length and the tilt.
CAMSHAFTS Inspect Replace			●		●	Inspect the camshaft surface.
TIMING CHAIN SPROCKETS, TIMING CHAIN Inspect Replace			●		●	Check for wear on the teeth and for damage.
PISTON Inspect Clean Replace			●		● ● ●	Inspect crack Inspect carbon deposits and eliminate them.

## MAINTENANCE INTERVALS

Item	After break-in (50km)	Every race	Every third (or 500 km)	Every fifth (or 1,000 km)	As required	Remarks
PISTON RING Inspect Replace			● ●		●	Check ring end gap
PISTON PIN Inspect Replace			●		●	
CYLINDER HEAD Inspect and clean Replace			●		●	Inspect carbon deposits and eliminate them. Change gasket
CYLINDER Inspect and clean Replace			●		●	Inspect score marks Inspect wear
CLUTCH Inspect and adjust Replace	●	●			●	Inspect housing, friction plate, clutch plate and spring
TRANSMISSION Inspect Replace				●	●	Inspect wear of gear and bearings
SHIFT FORK, SHIFT CAM, GUIDE BAR Inspect Replace				●	●	Inspect wear
ROTOR NUT Retighten	●			●		
CRANK Inspect and align				●	●	
CARBURETOR Inspect, adjust, clean	●	●				

## MAINTENANCE INTERVALS

---

Item	After break-in (50km)	Every race	Every third (or 500 km)	Every fifth (or 1,000 km)	As required	Remarks
SPARK PLUG Inspect and clean Replace	●		●		●	
OIL COOLING SYSTEM(Optional) Check hoses & leakage Replace hoses and gaskets	●	●			●	
AIR FILTER (Optional) Clean and lubricate Replace	●	●			●	Use foam air-filter oil or equivalent oil
OIL FILTER Replace	●	●				
OIL STRAINER Clean				●		

## **PRE-OPERATION INSPECTION AND MAINTENANCE**

---

Before riding for break-in operation, practice or a race, make sure the engine is in good operating condition.

Before using this engine, check the following points.

### **ENGINE OIL LEVEL INSPECTION**

1. Start the engine, warm it up for several minutes, and then turn off the engine and wait for a few minutes.
2. Place the bike on a level place and hold it up on upright position.
3. Check the oil level through the sight glass.

Oil level should be between the upper and the central point of the sight glass.

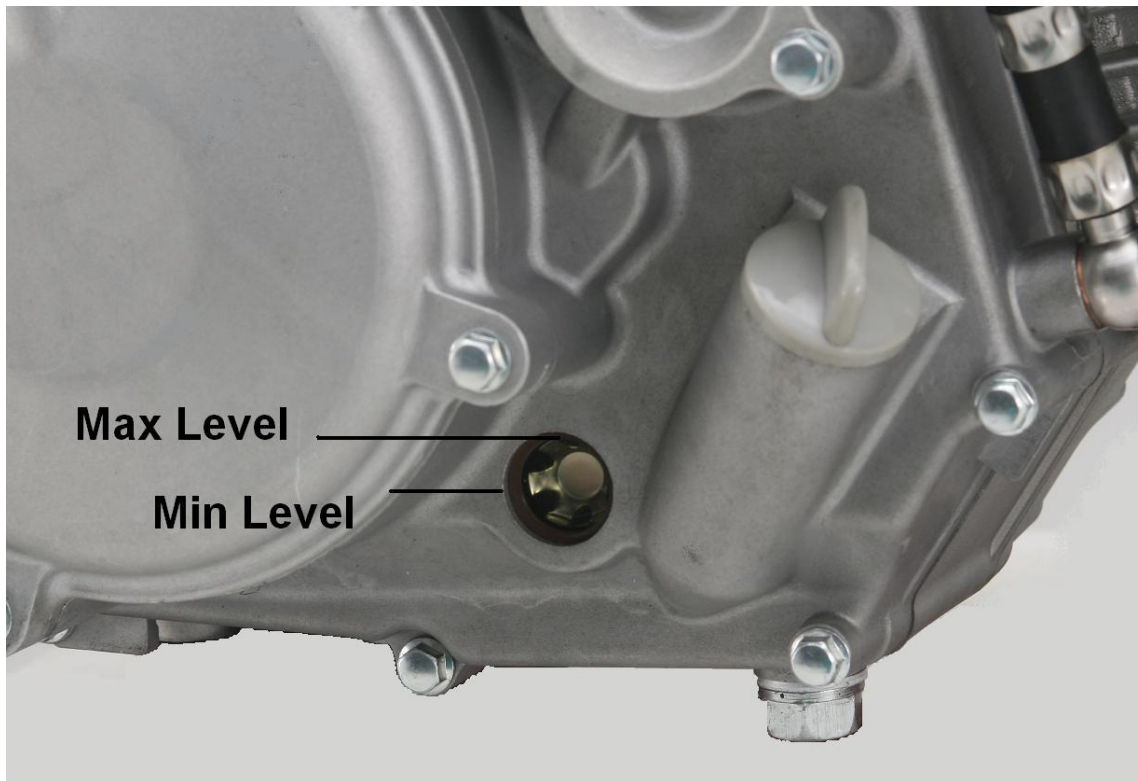

4. Add oil to proper level



### **WARNING**

Add oil as necessary, when install the oil cooler.

## PRE-OPERATION INSPECTION AND MAINTENANCE

---

### CARBURETOR SETTING

The carburetor is extremely sensitive to foreign matter (dirt, sand, water, etc.).

During installation, do not allow foreign matter to get into the carburetor.

Always handle the carburetor and its components carefully. Even slight scratches, bends or damage to carburetor parts may prevent the carburetor from functioning correctly.

Carefully perform all servicing with the appropriate tools and without applying excessive force.

After installing the carburetor, check that the throttle operates correctly and opens and closes smoothly.

It is highly recommended that the carburetor setting is performed by an experienced mechanic to obtain the best possible performance.

Atmospheric conditions and carburetor settings

Air Temp.	Humidity	Air Pressure (Altitude)	Mixture	Setting
High	High	Low (High)	Richer	Leaner
Low	Low	High (Low)	Leaner	Richer

The air density (i.e., concentration of oxygen in the air) determines the richness or leanness of the air/fuel mixture. Therefore, refer to the above table for mixture settings.

That is:

- Higher temperature expands the air with its resultant reduced density.
- Higher humidity reduces the amount of oxygen in the air by so much of the water vapor in the same air.
- Lower atmospheric pressure (at a high altitude) reduces the density of the air.

## PRE-OPERATION INSPECTION AND MAINTENANCE

Effects of the setting parts on the throttle valve opening

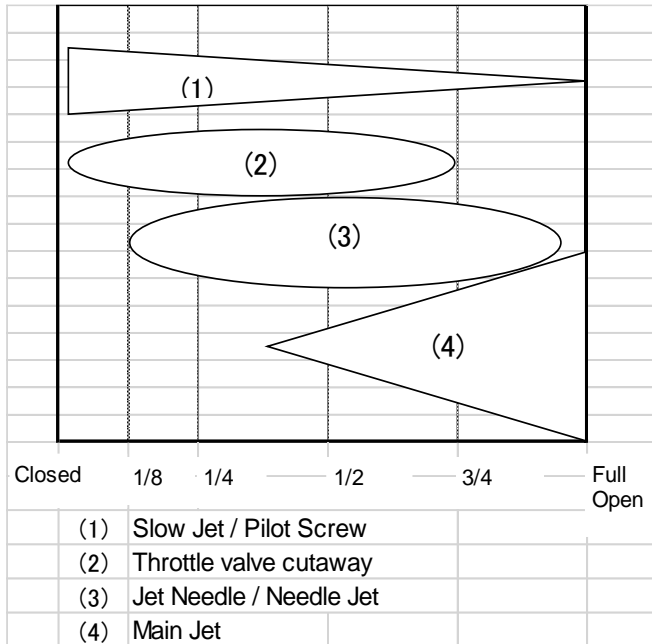

Here is the recommended setting information of TK MV33-1F and PE28 carburetor, for your reference.

### Tested Conditions

Carburetor	TK MV33-1F (DT#88600)
Air Temperature	35 degrees Celsius
Humidity	50%
Atmospheric Pressure	1003 hPa
with UNI Air Filter (#UP-4200ST)	
Fuel	Octane#100

Item	Recommendation
Main Jet	#129
Slow Jet	#38
Main No	$\phi$ 2.600
Jet Needle	5A11 Clip position : In the 5 <sup>th</sup> groove from the top
Pilot screw	2 return



## PRE-OPERATION INSPECTION AND MAINTENANCE

---

Carburetor	KEIHIN PE28 (DT#85707)
Air Temperature	20 degrees Celsius
Humidity	50%
Atmospheric Pressure	1000 hPa
with UNI Air Filter (#UP-4200ST)	
Fuel	Octane#100

Item	Recommendation
Main Jet	#122 (DT#87004)
Slow Jet	#38 (DT#89672)
Throttle Valve	#3.0 (Original of DT#85707)
Jet Needle	#65414 / 46JFQ (-2 / $\phi$ 2.505) or 46JFN : Original of KEIHIN PE28 (DT#85707)  Clip position : In the 2 <sup>nd</sup> or 3 <sup>rd</sup> groove from the top
Air screw	2 return

## PRE-OPERATION INSPECTION AND MAINTENANCE



---

### IGNITION TIMING SELECTION: FDX, FLX

ANIMA FDX/FLX ENGINE comes with ignition timing selectable CDI unit.

To change the ignition timing, it needs to change the connection of the wires that come out of the CDI unit.

WIRE CONNECTION TABLE

Color of Wire	WHITE	GREEN	YELLOW	GREEN	INGITION TIMING
Timing (1)	○	○	○	○	 REDUSE
Timing (2)	○	○	○ ——— ○		
Timing (3)	○ ——— ○		○	○	
Timing (4)	○ ——— ○		○ ——— ○		
 <b>WARNING</b> USE ADVANCE TIMING GIVES HIGH TEMPERATURE TO ENGINE. SERIOUS DAMAGE WILL OCCURE IN THE ENGINE BY ABNORMAL COMBUSTION.					

#### Notes

- (a) Reduce Timing gives more torque at low–middle rpm level.
- (b) Advance Timing gives more torque at higher rpm level than the Reduce Timing.

Example (How to select)

- \* To select Timing (2), connect Yellow and Green wires.

## PRE-OPERATION INSPECTION AND MAINTENANCE

---

### REV LIMITER SELECTION: FDX, FLX

ANIMA FDX/FLX ENGINE comes with rev limiter selectable CDI unit.

To change the rev limiter, it needs to change the connection of the wires that come out of the CDI unit.

#### WIRE CONNECTION TABLE

Color of Wire	BLUE	GREEN	BLACK/ YELLOW
Rev Limiter (1) -11,500rpm	○	○	○
Rev Limiter (2) -12,200rpm	○	○—	○
Rev Limiter (3) -12,900rpm	○—	○	○

Example (How to select)

\* To select Rev Limiter (3)-12,900rpm, connect Blue and Green wires.

## PRE-OPERATION INSPECTION AND MAINTENANCE

---

### ENGINE OIL TEMPERATURE CONTROL



#### WARNING

Engine oil temperature is to be strictly controlled at 90 degrees Celsius (194 degrees Fahrenheit) or lower.

Serious damage will occur in the engine if engine oil temperature exceeds 90 degrees Celsius or 194 degrees Fahrenheit.

It is solely customer's responsibility to control the engine oil temperature.

Any failures caused by overheating are NOT considered as the defects of Products.

It is highly recommended to use HIGH-EFFICIENT OIL COOLER and OIL TEMPERATURE GAUGE to protect the engine.



The above OIL COOLER is just a recommendation.

Engine oil temperature can be heated up over 90 degrees Celsius or 194 degrees Fahrenheit, even if the above recommended OIL COOLER is used.

Again, customer needs to control the oil temperature very carefully.

# ELECTRICAL DIAGRAM for FDX

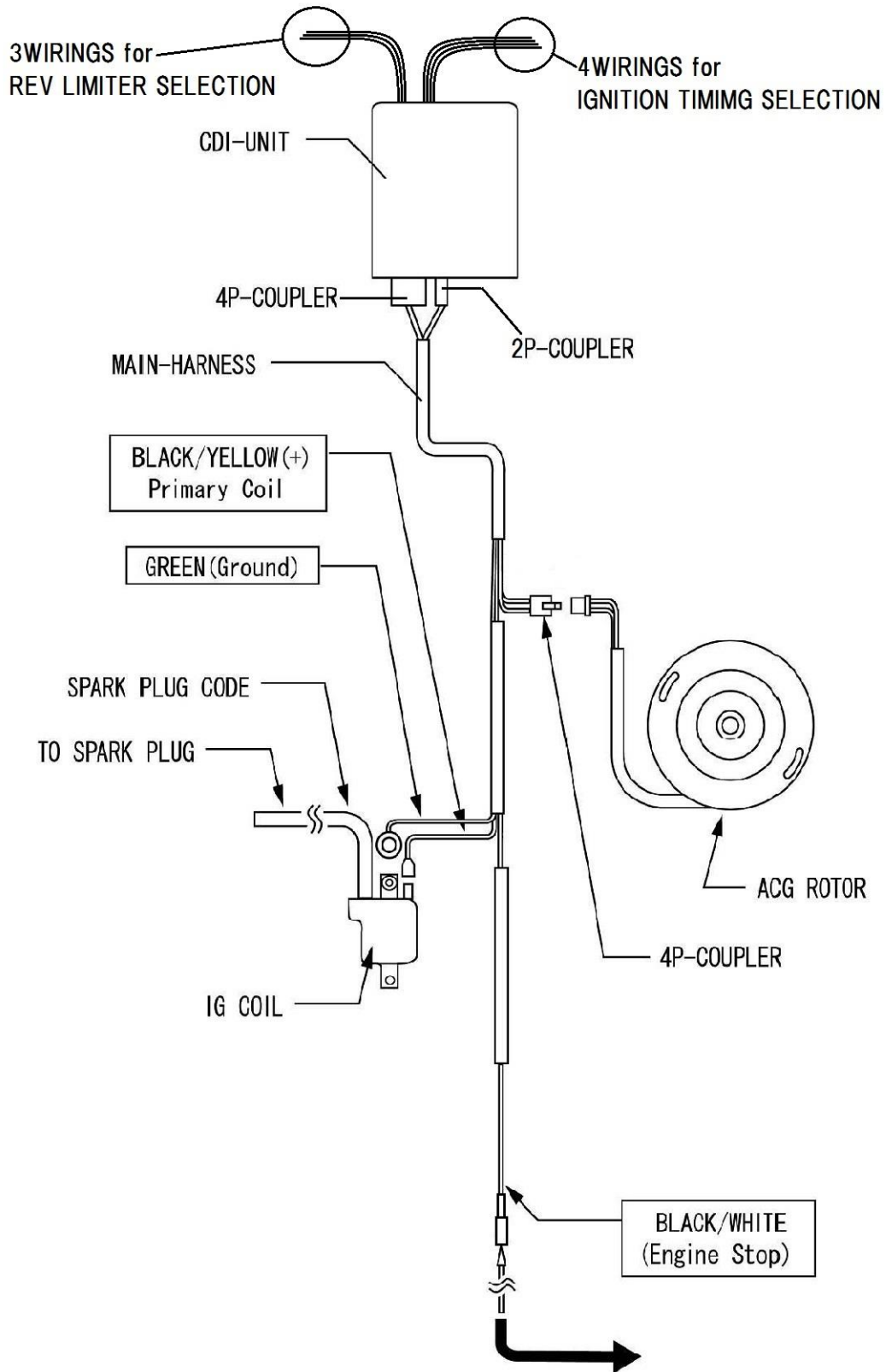

## TIGHTENING TORQUE

---

### Standard

Size	Tightening Torque N.m (kgf.m)	Size	Tightening Torque N.m (kgf.m)
5mm Bolt, Nut	5.2 (0.5)	5mm Screw	4.2 (0.4)
6mm Bolt, Nut	10 (1.0)	6mm Screw	9.0 (0.9)
8mm Bolt, Nut	22 (2.2)	6mm Screw (Small Flange)	10 (1.0)
10mm Bolt, Nut	34 (3.5)	6mm Screw (Large Flange)	12 (1.2)
12mm Bolt, Nut	54 (5.5)	8mm Flange Bolt, Nut	27 (2.8)
		10mm Flange Bolt, Nut	39 (4.0)

### Others

Nut M8, Cylinder Head : 22N.m (2.2kgf.m)

Nut M14, Clutch center and Primary Gear : 44N.m (4.5kgf.m)

Nut M12, Magnet Rotor : 59N.m (6.0kgf.m)

Bolt M12, Oil Drain : 24N.m (2.4kgf.m)

***DAYTONA*** corp.

2022.01.25